

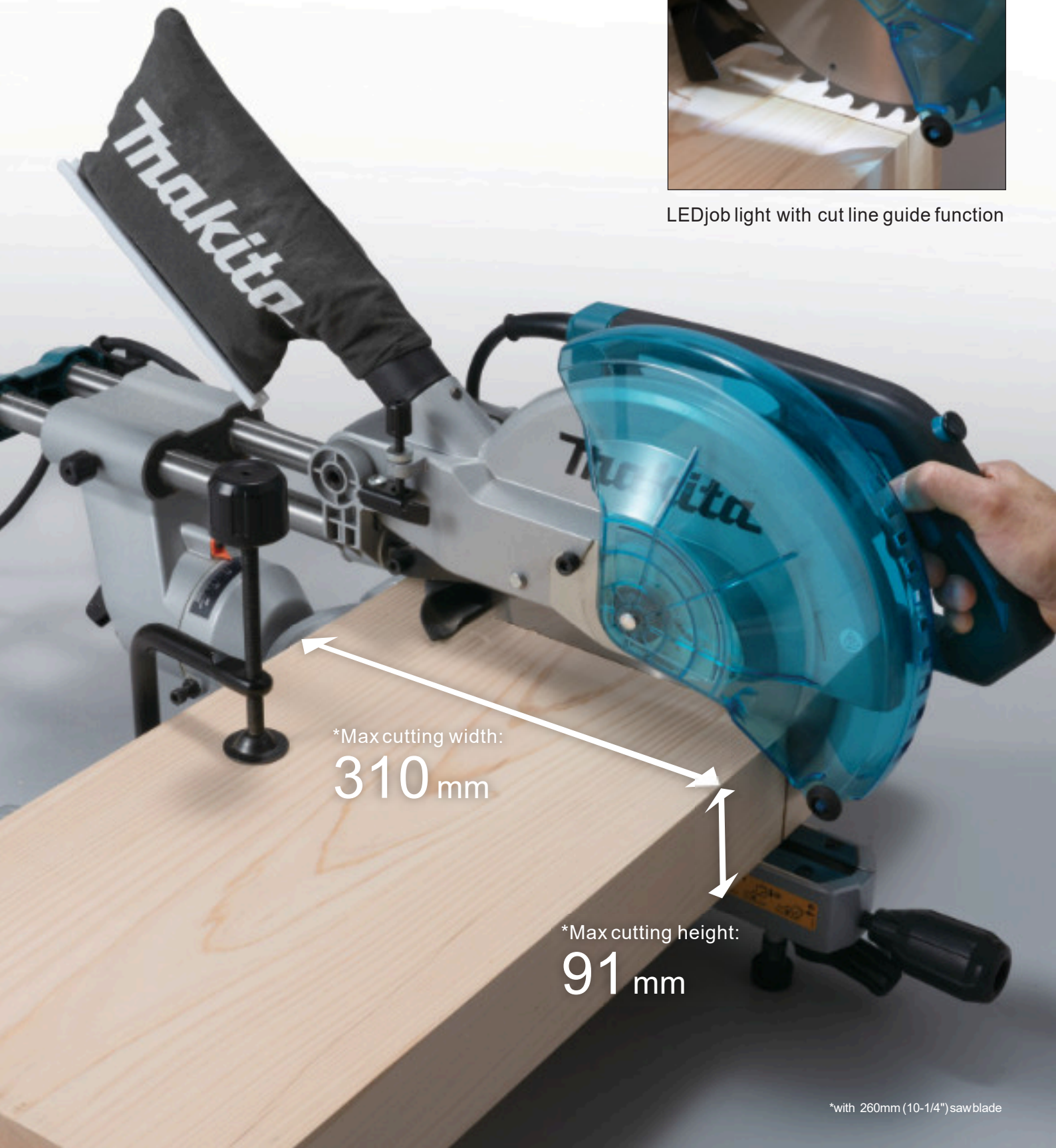

# Slide Compound Miter Saw LS1110F<sub>255 - 260 mm (10 - 10-1/4")</sub>



LED job light with cut line guide function



\*Max cutting width:  
**310 mm**

\*Max cutting height:  
**91 mm**

\*with 260mm (10-1/4") saw blade

LED job light with cut line guide function

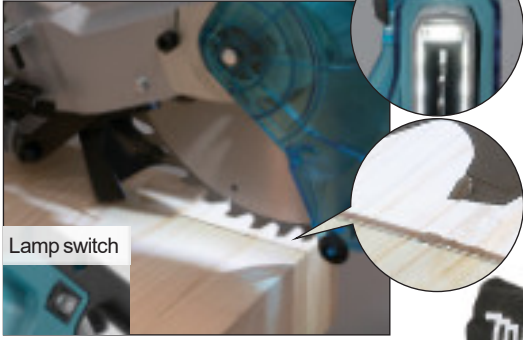

Lamp switch

LED job light casts a shadow of the saw blade onto the workpiece as an exact cutting line. By aligning the shadow with the ink line on the workpiece, you can make an exact cut.

Carrying handle for easy transportation to job site

Soft grip

Sub base can be pulled out for more stable cutting of wide workpiece.

Bevel range of 47° left and 2° right

Easy bevel angle change from 45° to 47° left and from 0° to 2° right with simple operation of a push-button

Lever (for bevel angle)

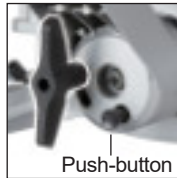

Push-button

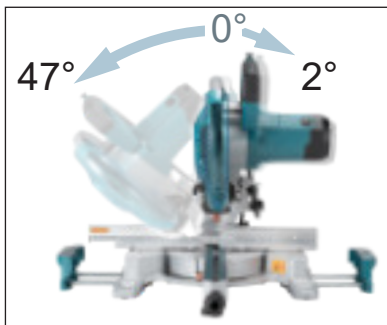

Slide style sub fence

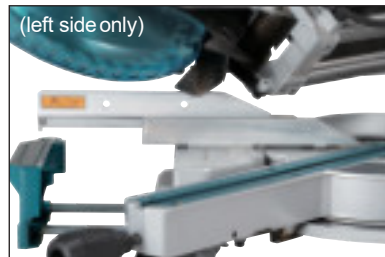

(left side only)

Miter range of 47° left and 47° right



### Cutting capacity (height x width)

with 260mm (10-1/4") saw blade

Cross Cut

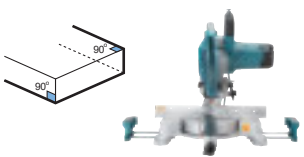

Miter Cut (left & right)

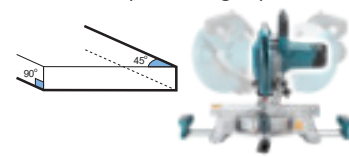

Miter 0° Bevel 0°	91 x 310 mm (3-5/8 x 12-1/4")	Miter 45° left / right Bevel 0°	91 x 220 mm (3-5/8 x 8-5/8")
----------------------	----------------------------------	------------------------------------	---------------------------------

Bevel Cut (left & right)

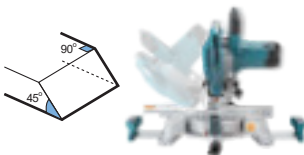

Compound Cut

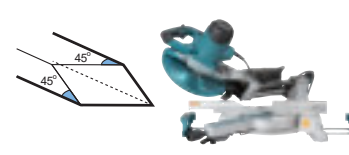

Miter 0° Bevel 45° left	50 x 310 mm (2 x 12-1/4")	Miter 45° left / right Bevel 45° left	50 x 220 mm (2 x 8-5/8")
Miter 0° Bevel 2° right	85 x 310 mm (3-3/8 x 12-1/4")		

### Optional Accessories

Miter Saw Stand WST06



### Slide Compound Miter Saw

LS1110F 255 - 260 mm (10 - 10-1/4")

Double Insulation	Continuous rating Input	1,450W
Brake	Wheel diameter	255 - 260 mm (10 - 10-1/4")
Soft Start	Bevel angle	Left: 47° / Right: 2°
Dust Collection	Miter angle	Left: 47° / Right: 47°
Built-in Job Light	No load speed (RPM)	4,500 min <sup>-1</sup>
Led Marker	Sound pressure level	91 dB(A)
	Sound power level	102 dB(A)
	Dimensions (L x W x H)	745 x 497 x 565 mm
	Net weight	(29-1/4 x 19-1/2 x 22-1/4")
	Power supply cord	16.4 kg (36.2 lbs.)
		2.0 m (6.6 ft)

Standard Equipment : LS1110F: TCT SAW 260X40T: D-77338(1), UNI. HEX KEY WRENCH 6MM & PH2: JM00000445(1)



Makita Power Tools India Pvt. Ltd.

Unit II Sy. Nos. 93/3 & 93/4, Koralur Village, Kasaba Hobli,  
Hoskote Taluk, Bengaluru - 560067  
Email: info@makita.in Website: www.makita.in