

Model No. UH4261 420MM HEDGE TRIMMER

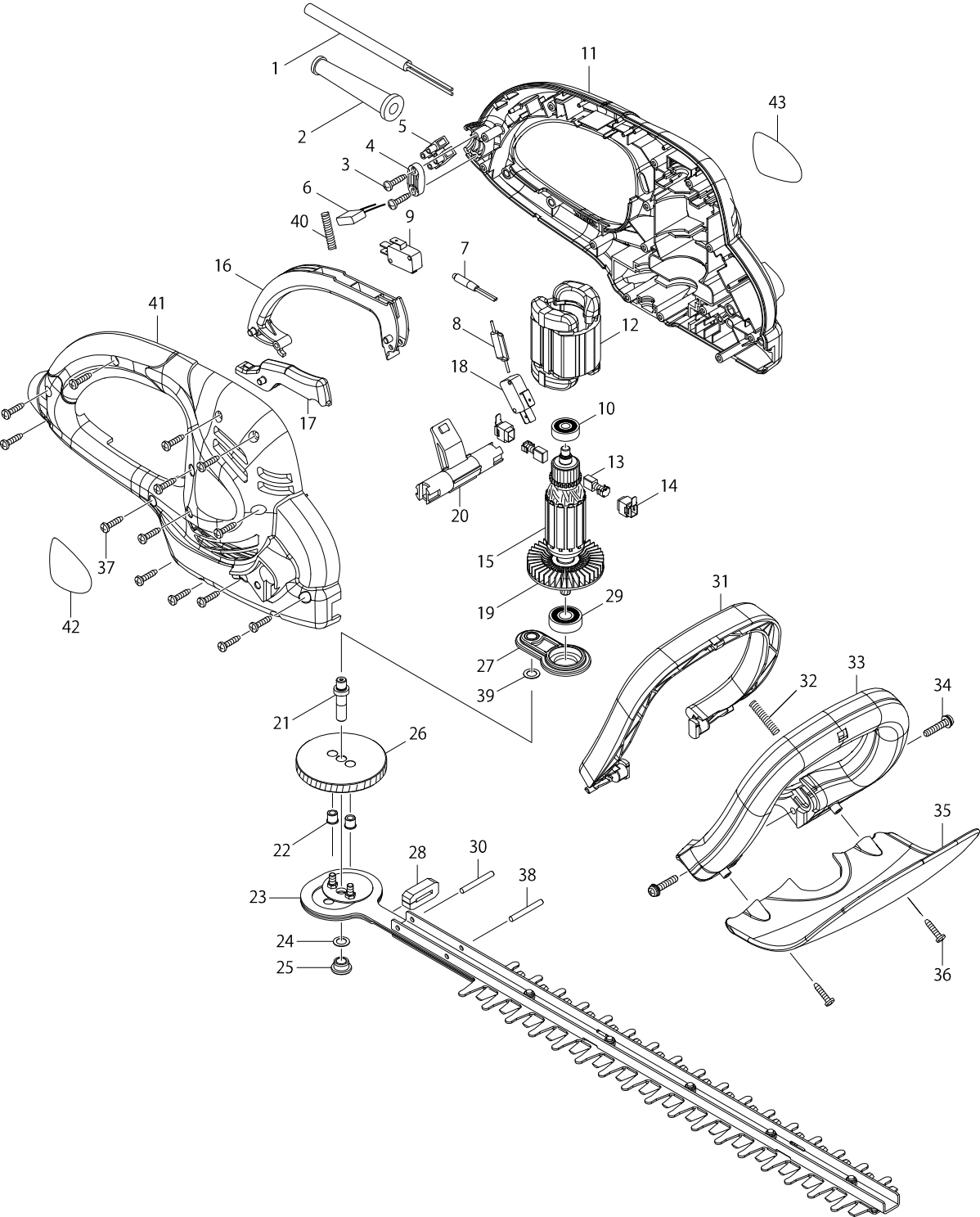

Model No. UH4261 420MM HEDGE TRIMMER

Item	Parts No.	Description	I/C	QTY	N/O	Opt. 1	Opt. 2	NOTE
001	666080-2	POWER SUPPLY CORD 1.0-2-0.3		1		85442090		
002	682569-2	CORD GUARD 8-85		1		73182990		
003	266326-2	TAPPING SCREW 4X18		2		73181500		
004	687123-7	STRAIN RELIEF		1		84679900		
005	654531-7	TERMINAL BLOCK 2P		1		73182990		
009	650642-6	SWITCH		1		85366990		
010	210030-5	BALL BEARING 627ZZ		1		84821090		
011	187052-9	HOUSING SET		1		84679900		
C10	931202-6	HEX. NUT M5		2		73181500		
D10		INC. 41,43						
012	621753-4	FIELD 220-240V		1		85030090		
013	191962-4	CARBON BRUSH CB-419		1		85452000		
014	643923-5	BRUSH HOLDER		2		82078000		
015	515824-6	ARMATURE ASS'Y 240V		1		85030090		
D10		INC. 10,19,29						
016	452677-1	SWITCH LEVER A		1		39269099		
017	452680-2	SWITCH LEVER C		1		39269099		
018	650642-6	SWITCH		1		85366990		
019	241850-6	FAN 60		1		84145190		
020	452681-0	SWITCH ARM		1		39269099		
021	326034-8	SPINDLE		1		84679900		
022	262570-9	NYLON SLEEVE 5		2		73182990		
023	140826-9	SHEAR BLADE COMPLETE		1		82029990		
024	253777-8	FLAT WASHER 8		1		84679900		
025	214064-0	PLANE BEARING 8		1		84821090		
026	227745-7	HELICAL GEAR 67		1	*	84679900		
026-1	227745-7	HELICAL GEAR 67	O	1		84679900		
027	140828-5	BEARING BOX COMPLETE		1		73262090		
028	423417-4	DUST GUARD		1		84679900		
029	211062-5	BALL BEARING 6000ZZ		1		84821090		
030	268136-3	PIN 4		1		73182990		
031	452678-9	SWITCH LEVER B		1		39269099		
032	233156-6	COMPRESSION SPRING 5		1		73209090		
033	452682-8	FRONT GRIP		1		40169390		
034	911243-8	PAN HEAD SCREW M5X25		2		73181500		
035	140829-3	PROTECTOR COMPLETE		1		84679900		
036	266326-2	TAPPING SCREW 4X18		2		73181500		
037	266326-2	TAPPING SCREW 4X18		14		73181500		
038	268136-3	PIN 4		1		73182990		
039	253777-8	FLAT WASHER 8		1		84679900		
040	233156-6	COMPRESSION SPRING 5		1		73209090		
041	187052-9	HOUSING SET		1		84679900		
C10	931202-6	HEX. NUT M5		2		73181500		
D10		INC. 11,43						
042	869243-1	UH4261 NAME PLATE		1				
043	892589-0	MAKITA LOGO LABEL		1				
A01	194677-2	CORD HOLDER COMPLETE SET		1		84679900		
A02	158024-1	HOOK COMPLETE		1		84679900		

