

Overview	2
Technical data	3
Instrument Set-up	5
Operations	8
How to use the adapters and wall mount	11
Message Codes	13
Accuracy Check	14
Care	18
Safety instructions	19
Optional accessories	24

Overview

The Makita SK106D/SK106GD is a self-levelling multifunctional laser. It combines the advantage of a cross-line laser and a point laser in one tool. It is a reliable precision laser for any kind of tasks like levelling, plumbing, transferring and setting out right angles.

It supports you on job side with two crossing vertical and horizontal lines and five points (four points and one intersection point in front of the instrument) which are arranged precisely in 90° to each other.

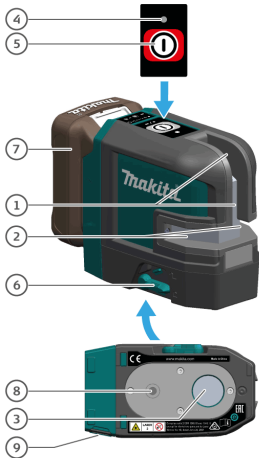

- 1 Window of vertical line and plumb point
- 2 Window of horizontal line and horizontal transfer points
- 3 Window of plumbing
- 4 Status LED
- 5 ON / Set key
- 6 **Levelling lock / Transportation lock**
- 7 **Battery (optional)**
- 8 Tripod thread 1/4"
- 9 DC jack

There are 2 different types available:

- SK106D (red laser)
- SK106GD (green laser)

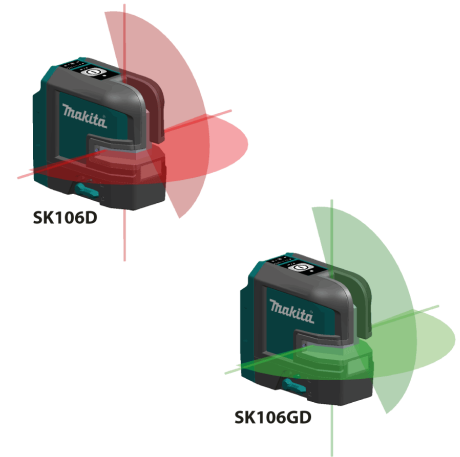

i On all images in this document only the SK106D is shown.

Technical data

Description	SK106D	SK106GD
Beam direction/fan angle		Vertical/ >170°, Horizontal/ >180°
Range*	25 m (82 ft)	35 m (115 ft)
Range* with receiver		80 m (262 ft)
Levelling accuracy		±0.3 mm/m = ±3.0 mm @ 10m (±0.004 in/ft = ±0.12 in @ 33ft)
Horizontal/Vertical line accuracy		±0.3 mm/m (±0.004 in/ft)
Point accuracy		±0.2 mm/m (±0.002 in/ft)
Self-levelling range		± 4 °
Self-levelling time		< 3 s
Out-of-level warning		Yes - blink lines every 5 s
Levelling system		Automatic pendulum lockable
Laser type	635 ± 5 nm, Class 2 (acc. IEC 60825-1)	525 ± 5 nm, Class 2 (acc. IEC 60825-1)
Battery cartridge		BL 1015 / BL 1016 / BL 1020B / BL 1021B / BL 1040B / BL 1041B
Operating time with Li-Ion battery (2 beam + 4 point)	15 h (BL 1015/BL 1016) 20 h (BL 1020B/BL 1021B) 40 h (BL 1040B/BL 1041B)	7 h (BL 1015/BL 1016) 10 h (BL 1020B/BL 1021B) 20 h (BL 1040B/BL 1041B)
Net weight		0.48 kg
Weight with Li-Ion battery		0.69 kg - 0.85 kg
Power supply		Makita battery cartridge / USB adapter
Rated voltage		D.C. 10.8 V - 12 Vmax, D.C. in 5 V
Dimensions (L x W x H)		112 x 61 x 102 mm (4.41 x 2.40 x 4.01 in)
Operating temperature (instrument)		-10...+50 °C (+14...+122 °F)
Storage temperature (instrument)		-25...+70 °C (-13...+158 °F)
Laser line width at 5m distance		< 2 mm (<0.08 in)
Tripod thread		1/4" (+ 5/8" with adapter)
Pulse power for receiver		Yes, auto

* depending on lighting conditions

Please note the following:

- Due to our continuing program of research and development, the specifications herein are subject to change without notice.
- Specifications may differ from country to country.
- The weight may differ depending on the attachment(s), including the battery cartridge. The lightest and heaviest combination, according to EPTA-Procedure 01/2014, are shown in the table.
- Some of the battery cartridges listed above may not be available depending on your region of residence.

WARNING

Only use the battery cartridges listed above. Use of any other battery cartridges may cause injury and/or fire.

Introduction

 The safety instructions (see [Safety Instructions](#)) and the user manual should be read through carefully before the product is used for the first time.

 The person responsible for the product must ensure that all users understand these directions and adhere to them.

The symbols used have the following meanings:

WARNING

Indicates a potentially hazardous situation or an unintended use which, if not avoided, will result in death or serious injury.

CAUTION

Indicates a potentially hazardous situation or an unintended use which, if not avoided, may result in minor injury and/or appreciable material, financial and environmental damage.

 Important paragraphs which must be adhered to in practice as they enable the product to be used in a technically correct and efficient manner.

Levelling lock

Levelling unlocked

 In the unlocked position the instrument automatically levels itself within the specified inclination range. (See [Technical data](#))



Levelling locked

Turn the levelling lock in order to transport or tilt the instrument beyond the self-levelling range. When locked, the pendulum is fixed and the self-levelling function is deactivated. In this case the laser blinks every 5sec.



Laser receiver

To be able to detect the laser lines over long distances or in unfavourable lighting conditions, a laser receiver can be used.

 We recommend the Makita LDX1 laser receiver.

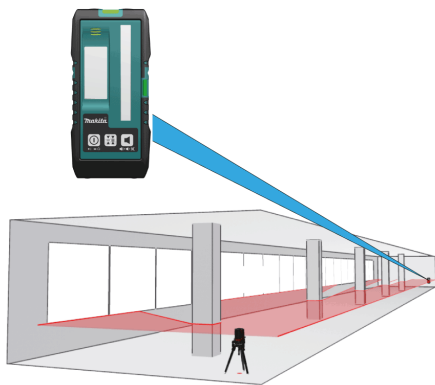

Li-Ion battery

Installing or removing battery cartridge

CAUTION

Always switch off the tool before installing or removing of the battery cartridge.

CAUTION

Hold the tool and the battery cartridge firmly when installing or removing battery cartridge. Failure to hold the tool and the battery cartridge firmly may cause them to slip off your hands and result in damage to the tool and battery cartridge and a personal injury.



To remove the battery cartridge, slide it from the tool while sliding the button (1) on the front of the cartridge.

To install the battery cartridge, align the tongue on the battery cartridge with the groove in the housing and slip it into place. Insert it all the way until it locks in place with a little click. If you can see the red indicator (2) on the upper side of the button, it is not locked completely.

CAUTION

Always install the battery cartridge fully until the red indicator cannot be seen. If not, it may accidentally fall out of the tool, causing injury to you or someone around you.

CAUTION

Do not install the battery cartridge forcibly. If the cartridge does not slide in easily, it is not being inserted correctly.

CAUTION

Connecting the wrong adapter may cause serious damage to the instrument. Any damage caused by misuse is not covered by warranty. Use only Makita approved batteries USB adapters and cables. Unapproved can damage the instrument.

Using the USB adapter (optional)



Makita CXT batteries

Indicating the remaining battery capacity

i Only for battery cartridges with the indicator

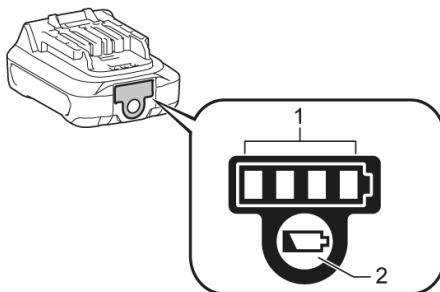

Press the check button (2) on the battery cartridge to indicate the remaining battery capacity. The indicator lamps (1) light up for a few seconds and show the remaining capacity:

	75% - 100%
	50% - 75%
	25% - 50%
	0% - 25%

i Depending on the conditions of use and the ambient temperature, the indication may differ slightly from the actual capacity.

Switching ON/Set key

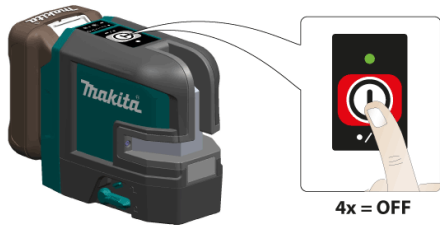

If the instrument is locked press laser key 3 times to switch off:

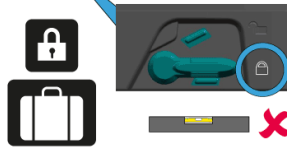

Brightness reduction



Functions with unlocked levelling

Horizontal / Vertical lines and dots

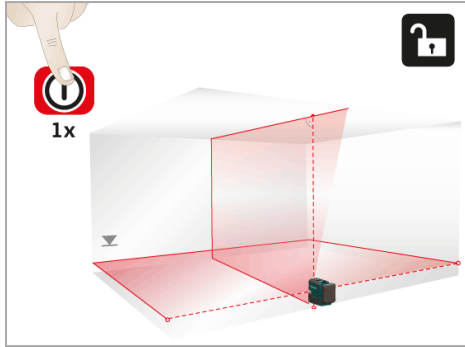

Horizontal line and dots

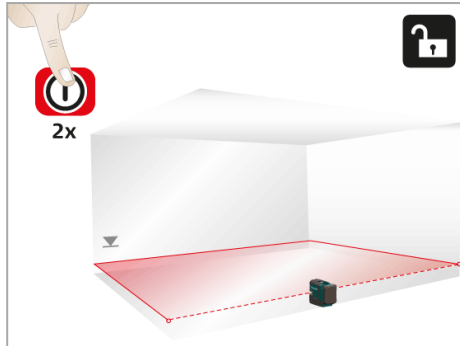

Vertical line and dots

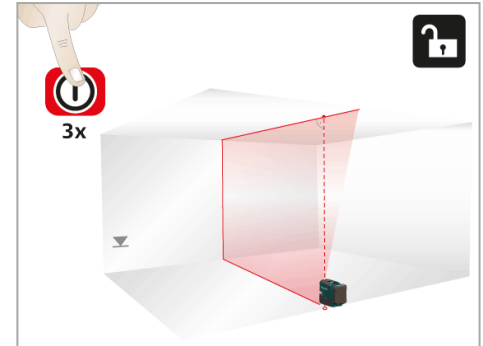

Functions with locked levelling

Horizontal line and dots

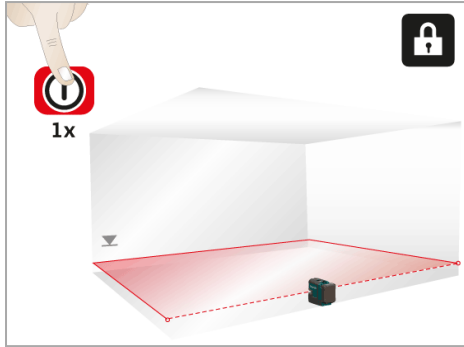

Vertical line and dots

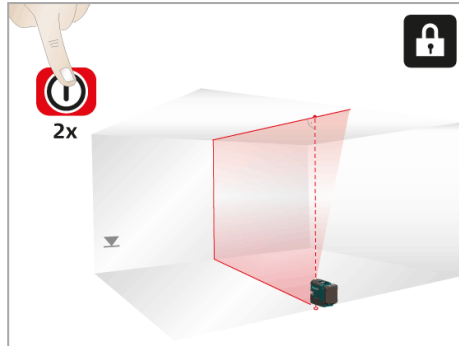

Horizontal line tilted

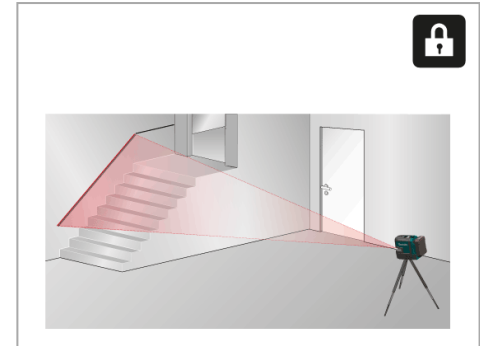

PRO L-adapter



Put the instrument on PRO L-adapter and fix it by thread.

i PRO L-Adapter can not be used when battery cartridge BL1040B or BL1041B is inserted.

Alignment of vertical laser lines



Turn the instrument 360° to adjust the vertical line.

Wall mount (optional accessory)

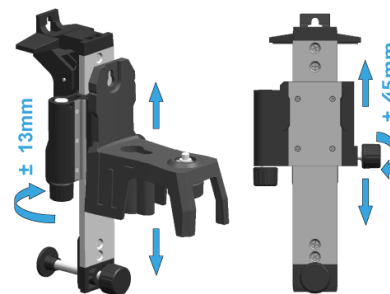

Turn the adjustment knob of the wall mount to loose and fix the slide for fine adjustment of the horizontal line to the desired reference level.

i The wall mount is a single item and will not be delivered with the PRO L-adapter as shown above.

How to use the adapters and wall mount

Different fixing applications

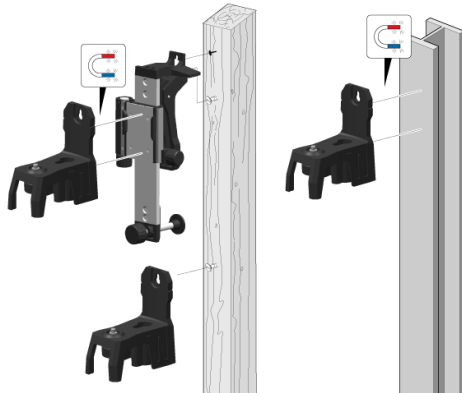
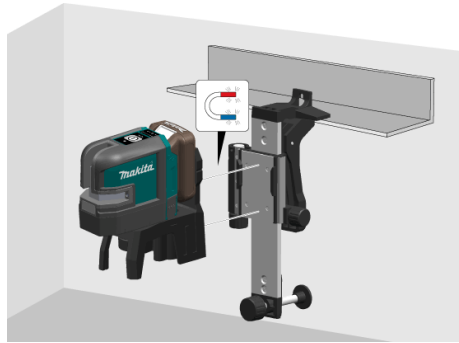
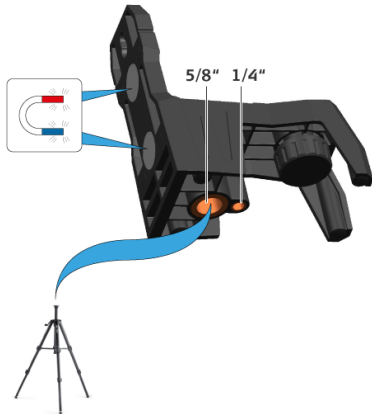

Message Codes

Laser	LED	Cause	Correction
ON	Lights green	Normal	-
ON	Blinks green	Normal, laser set at reduced brightness	OK - or press ON / Set key for 2 seconds to get strong laser beam
ON	Lights red	Instrument is at low power	Change power supply
OFF	Lights red 5 seconds then OFF	Battery empty	Change power supply
OFF	Blinks red	Temperature alert	Cool down - or heat up instrument
Blinks	Lights red	Instrument is out of self-levelling and instrument is at low power	Change power supply
Blinks	Blinks red	Instrument is out of self-levelling	Position the instrument almost horizontal
Blinks every 5 seconds	Lights red	Levelling lock is activated and instrument is at low power	Change power supply
Blinks every 5 seconds	Lights green	Normal, levelling lock is activated	-
Blinks every 5 seconds	Blinks green	Levelling lock is activated and laser set at reduced brightness	-

i Check the accuracy of your instrument regularly and particularly before important measuring tasks. Check [Levelling lock](#) before checking the accuracy.

Levelling

Checking the accuracy of the levelling

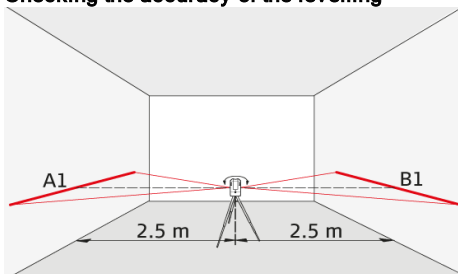

Set the instrument on a tripod half-way between two walls (A+B) that are approx. 5 m apart. Place the lock switch in the "Unlocked" position (see [Levelling lock](#)). Direct the instrument at wall A and switch on the instrument. Activate the horizontal laser line or laser point and mark the position of the line or the point on wall (A1). Rotate the instrument by 180° and mark the horizontal laser line or the laser point in exactly the same way on wall (B1).

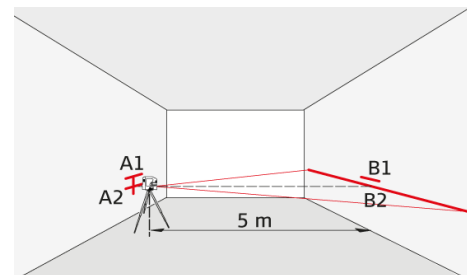

Then place the instrument at the same elevation as close as possible to wall A and again mark the horizontal laser line or the laser point on wall A (A2). Rotate the instrument by 180° again and mark the laser on wall B (B2). Measure the distances of the marked points A1-A2 and B1-B2. Calculate the difference of the two measurements.

$$|(A1 - A2) - (B1 - B2)| \leq 2 \text{ mm}$$

If the difference does not exceed 2 mm, then the instrument is within tolerance.

i Should your instrument be outside of the specified tolerance, please contact a local dealer or an authorised Makita distributor.

Vertical and horizontal line

Checking the accuracy of the horizontal line

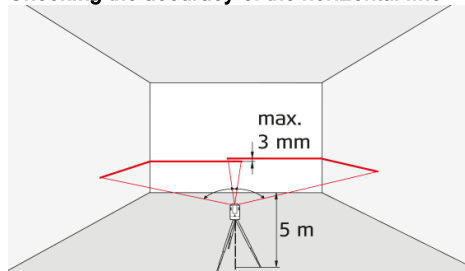

Place the lock switch in the "Unlocked" position (see [Levelling lock](#)). Position the instrument approx. 5 m away from the wall. Direct the instrument at the wall and switch on. Activate the laser line and mark the intersection point of laser crosshairs on the wall. Swivel the instrument to the right and then to the left. Observe the vertical deviation of the horizontal line from the marking. If the difference does not exceed 3 mm, then the instrument is within tolerance.

Checking the accuracy of the vertical line

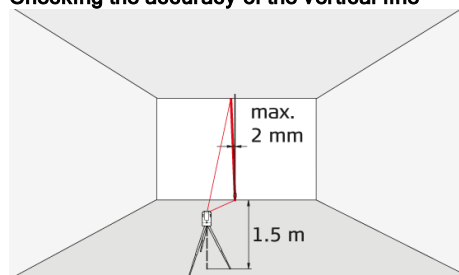

Place the lock switch in the "Unlocked" position (see [Levelling lock](#)). As a reference, use a plumb-bob and attach it as close as possible to an approx. 3 m high wall. Position the instrument at a distance of approx. 1.5 m from the wall at an elevation of approx. 1.5 m. Direct the instrument at the wall and switch on. Rotate the instrument and align it with the bottom of the plumb line. Now read off the maximum deviation of the laser line from the top of the plumb line. If the difference does not exceed 2 mm, then the instrument is within tolerance.

i Should your instrument be outside of the specified tolerance, please contact a local dealer or an authorised Makita distributor.

Vertical plumb points

Checking the accuracy of the upper plumb point:

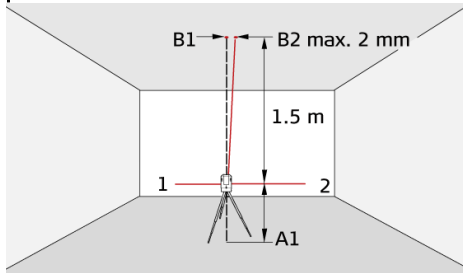

Place the lock switch in the "Unlocked" position (see [Levelling lock](#)). Set up the laser on its tripod to wall mount bracket near point A1 at a minimum distance of 1.5 m from point B1. The horizontal laser is aligned in direction 1. Mark the laser points A1 and B1 with a pin.

Checking the accuracy of the lower plumb point:

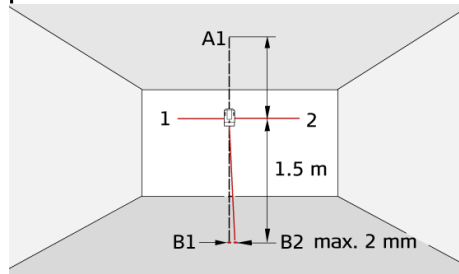

Rotate the instrument by 180° so that it points in the opposite direction 2 to direction 1. Adjust the instrument so that the laser beam hits point A1 exactly. If point B2 is no further than 2 mm away from point B1, then the instrument is within tolerance.

i Should your instrument be outside of the specified tolerance, please contact a local dealer or an authorised Makita distributor.

Perpendicularity horizontal points

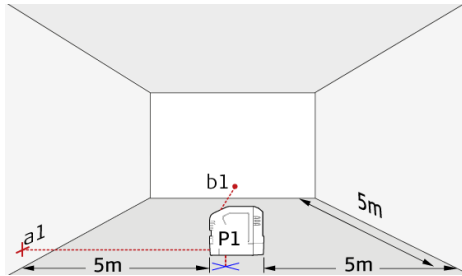

Place lock switch in "Unlocked" position (see [Levelling lock](#)). Mark a reference point (P1) approx. 5m from the walls and position the lower plumb point exactly on it. Align the cross hair to the left wall and mark the intersection point (a1) approx. on the same height like P1 to the wall. Shortly after mark the right-hand perpendicular beam (b1) on the front wall.

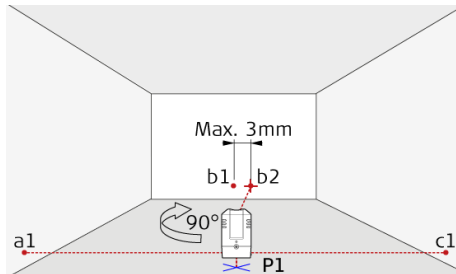

Then rotate the instrument exactly 90° clockwise around the plumb point P1 and position the left-hand perpendicular beam to the existing reference point a1. Make sure that the upper plumb point is still exactly on the reference P1. Check afterwards the new reference point b2 with the old reference b1 on the front wall. The deviation between the two points may be max. 3mm. Mark the new position of the right-hand perpendicular beam to the right wall with c1.

i Should your instrument be outside of the specified tolerance, please contact a local dealer or an authorised Makita distributor.

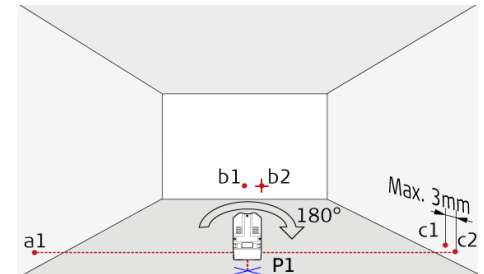

Afterwards turn the instrument exactly 180° around the plumb point P1 and position the right-hand perpendicular beam to the existing reference point a1. Make sure that the upper plumb point is still exactly on the reference P1. Then mark the left-hand beam to the right wall and mark it with c2. Finally measure the difference between the former reference point c1 and the new point c2. The deviation may be max. 3mm between these two points.

i Should your instrument be outside of the specified tolerance, please contact a local dealer or an authorised Makita distributor.

Never immerse the instrument in water. Wipe off dirt with a damp soft cloth. Never use aggressive cleaning agents or solvents. Treat the instrument with the same care that you would apply to binoculars or a camera. Dropping or violent shaking of the instrument may damage it. Check the instrument for any damage before using it. Check the [levelling accuracy](#) of the instrument regularly.

To warranty the best precision and visibility please clean the optics of your instrument regularly. Therefore blow off the dust from the glasses without touching the optics with your fingers. If necessary use a damp soft cloth and a little bit of pure alcohol.

To avoid wrong measurements also clean your adapters regularly. This could be done also by the proposed recommendation. Especially the interface between the adapter and instrument should always be clean to enable easy rotation. To clean the magnetic surface you could use compressed air or modelling clay.

If the equipment get wet always dry it (max. 70°C/158°F) before repacking it into the case.



The person responsible for the instrument must ensure that all users understand these directions and adhere to them.

Areas of responsibility

Responsibilities of the manufacturer of the original equipment:

Makita Corporation Anjo, 3-11-8, Sumiyoshi-cho, Aichi 446-8502, Japan
Makita, Jan-Baptist Vinkstraat 2, 3070, Belgium
Internet: www.makita.com

The company above is responsible for supplying the product, including the User Manual in a completely safe condition.

The company above is not responsible for third party accessories.

Responsibilities of the person in charge of the instrument:

1. To understand the safety instructions on the product and the instructions in the User Manual.
2. To be familiar with local safety regulations relating to accident prevention.
3. Always prevent access to the product by unauthorised personnel.

Permitted use

1. Projection of horizontal and vertical laser lines and laser points

Prohibited use

1. Using the product without instruction
2. Using outside the stated limits
3. Deactivation of safety systems and removal of explanatory and hazard labels
4. Opening of the equipment by using tools (screwdrivers, etc.)
5. Carrying out modification or conversion of the product
6. Deliberate dazzling of third parties; also in the dark
7. Inadequate safeguards at the surveying site (e.g. when measuring on roads, construction sites, etc.)

Hazards in use

WARNING

Watch out for erroneous measurements if the instrument is defective or if it has been dropped or has been misused or modified. Carry out periodic test measurements. Particularly after the instrument has been subject to abnormal use, and before, during and after important measurements.

CAUTION

Never attempt to repair the product yourself. In case of damage, contact a local dealer.

WARNING

Changes or modifications not expressly approved by Makita/manufacturer for compliance could void the user's authority to operate the equipment.

CAUTION

Laser light is bright and blinding. Do not shine at aircraft or vehicles at any distances.

WARNING

Makita Line Laser and L-adapter / PRO L-adapter should not be used in the vicinity of pacemaker because of integrated magnets which can affect the function of the pacemaker.

Battery tool use and care

1. Recharge only with the charger specified by the manufacturer. A charger that is suitable for one type of battery pack may create a risk of fire when used with another battery pack.
2. Use power tools only with specifically designated battery packs. Use of any other battery packs may create a risk of injury and fire.
3. When battery pack is not in use, keep it away from other metal objects, like paper clips, coins, keys, nails, screws or other small metal objects, that can make a connection from one terminal to another. Shorting the battery terminals together may cause burns or a fire.
4. Under abusive conditions, liquid may be ejected from the battery; avoid contact. If contact accidentally occurs, flush with water. If liquid contacts eyes, additionally seek medical help. Liquid ejected from the battery may cause irritation or burns.
5. Do not use a battery pack or tool that is damaged or modified. Damaged or modified batteries may exhibit unpredictable behaviour resulting in fire, explosion or risk of injury.
6. Do not expose a battery pack or tool to fire or excessive temperature. Exposure to fire or temperature above 130 °C may cause explosion.
7. Follow all charging instructions and do not charge the battery pack or tool

outside the temperature range specified in the instructions. Charging improperly or at temperatures outside the specified range may damage the battery and increase the risk of fire.

Important safety instructions for battery cartridge

1. Before using battery cartridge, read all instructions and cautionary markings on (1) battery charger, (2) battery, and (3) product using battery.
2. Do not disassemble battery cartridge.
3. If operating time has become excessively shorter, stop operating immediately. It may result in a risk of overheating, possible burns and even an explosion.
4. If electrolyte gets into your eyes, rinse them out with clear water and seek medical attention right away. It may result in loss of your eyesight.
5. Do not short the battery cartridge:
(1) Do not touch the terminals with any conductive material.
(2) Avoid storing battery cartridge in a container with other metal objects such as nails, coins, etc.
(3) Do not expose battery cartridge to water or rain. A battery short can cause a large current flow, overheating, possible burns and even a breakdown.
6. Do not store the battery cartridge in locations where the temperature may reach or exceed 50 °C (122 °F).

7. Do not incinerate the battery cartridge even if it is severely damaged or is completely worn out. The battery cartridge can explode in a fire.
8. Be careful not to drop or strike battery.
9. Do not use a damaged battery.
10. The contained lithium-ion batteries are subject to the Dangerous Goods Legislation requirements.
For commercial transports e.g. by third parties, forwarding agents, special requirement on packaging and labeling must be observed. For preparation of the item being shipped, consulting an expert for hazardous material is required. Please also observe possibly more detailed national regulations.
Tape or mask off open contacts and pack up the battery in such a manner that it cannot move around in the packaging.
11. Follow your local regulations relating to disposal of battery.
12. Use the batteries only with the products specified by Makita. Installing the batteries to non-compliant products may result in a fire, excessive heat, explosion, or leak of electrolyte.

SAVE THESE INSTRUCTIONS.

CAUTION

Only use genuine Makita batteries. Use of non-genuine Makita batteries, or batteries that have been altered, may result in the battery bursting causing fires, personal injury and damage. It will also void the Makita warranty for the Makita tool and charger.

Tips for maintaining maximum battery life:

1. Charge the battery cartridge before completely discharged. Always stop tool operation and charge the battery cartridge when you notice less tool power.
2. Never recharge a fully charged battery cartridge. Overcharging shortens the battery service life.
3. Charge the battery cartridge with room temperature at 10 °C - 40 °C (50 °F - 104 °F). Let a hot battery cartridge cool down before charging it.

Limits of use

 Refer to section [Technical data](#). The instrument is designed for use in areas permanently habitable for humans. Do not use the product in explosion hazardous areas or in aggressive environments.

Disposal

CAUTION

Flat batteries must not be disposed of with household waste. Care for the environment and take them to the collection points provided in accordance with national or local regulations.

 The product must not be disposed with household waste. Dispose of the product appropriately in accordance with the national regulations in force in your country. Adhere to the national and country specific regulations.

Transport

Transport of instrument

Always set the instrument in "Locked" position by turning the lock switch when transporting the instrument (see [Levelling lock](#)). Please use the original case or an equivalent packaging for transporting and shipping your measuring instrument.



Electromagnetic Compatibility (EMC)

WARNING

The instrument conforms to the most stringent requirements of the relevant standards and regulations. However, the possibility of causing interference in other instruments cannot be totally excluded.

FCC statement (applicable in U.S.)

This equipment has been tested and found to comply with the limits for a Class B digital instrument, pursuant to part 15 of the FCC rules. These limits are designed to provide reasonable protection against harmful interference in a residential installation. This equipment generates, uses and can radiate radio frequency energy and, if not installed and used in accordance with the instructions, may cause harmful interference to radio communications.

However, there is no guarantee that interference will not occur in a particular installation. If this equipment does cause harmful interference to radio or television reception, which can be determined by turning the equipment off and on, the user is encouraged to try to correct the interference by one or more of the following measures:

1. Reorient or relocate the receiving antenna
2. Increase the separation between the equipment and the receiver

3. Connect the equipment into an outlet on a circuit different from that to which the receiver is connected
4. Consult the dealer or an experienced radio/TV technician for help

This instrument complies with part 15 of the FCC rules. Operation is subjected to the following two conditions:

1. This instrument may not cause harmful interference, and
2. this instrument must accept any interference received, including interference that may cause undesired operation.

ISED statement (applicable in Canada)

This instrument complies with Industry Canada license-exempt RSS standard(s). Operation is subjected to the following two conditions:

1. This instrument may not cause harmful interference, and
2. this instrument must accept any interference received, including interference that may cause undesired operation.

Laser classification

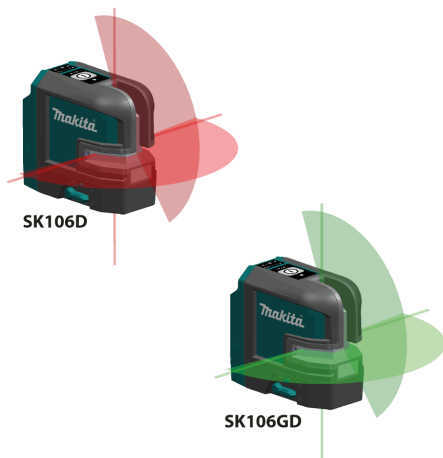

The instrument produces visible laser beams, which are emitted from the instrument. It is a Class 2 laser product in accordance with:

- IEC60825-1 : 2014 „Radiation safety of laser products“

Laser Class 2 products

Do not stare into the laser beam or direct it towards other people unnecessarily. Eye protection is normally afforded by aversion responses including the blink reflex.

WARNING

Looking directly into the beam with optical aids (e.g. binoculars, telescopes) can be hazardous.

CAUTION

Looking into the laser beam may be hazardous to the eyes.

Wavelength

SK106D: 635 +/- 5 nm (red) /
SK106GD: 525 +/- 5 nm (green)

Maximum radiant output power for classification

<1 mW

Pulse duration

45 - 70 μ s

Pulse repetition frequency

10 kHz

Beam divergence line

<200°

Beam divergence point

< 1.5 mrad

Labelling



SN123456789012
Manuf. 11.2017

Power supply:
Battery
10.8V \equiv - 12V \equiv (max)
DC IN 5V / 2.1A

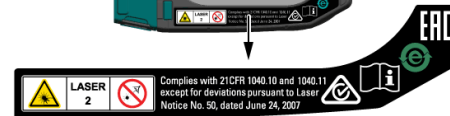
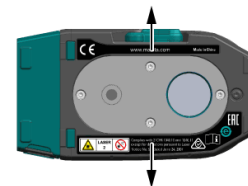

Subject to change (drawings, descriptions and technical data) without prior notice.

CAUTION

These accessories or attachments are recommended for use with your Makita tool specified in this manual. The use of any other accessories or attachments might present a risk of injury to persons. Only use accessory or attachment for its stated purpose.

- USB adapter
- Power supply cable
- Laser receiver LDX1
- Wall mount
- Tripod
- Laser viewing glass
- Storage case
- Target plate
- Hand strap
- Aluminium rod

 If you need any assistance for more details regarding these accessories, ask your local Makita Service Center.