

Model No. GA7060R 180MM ANGLE GRINDER

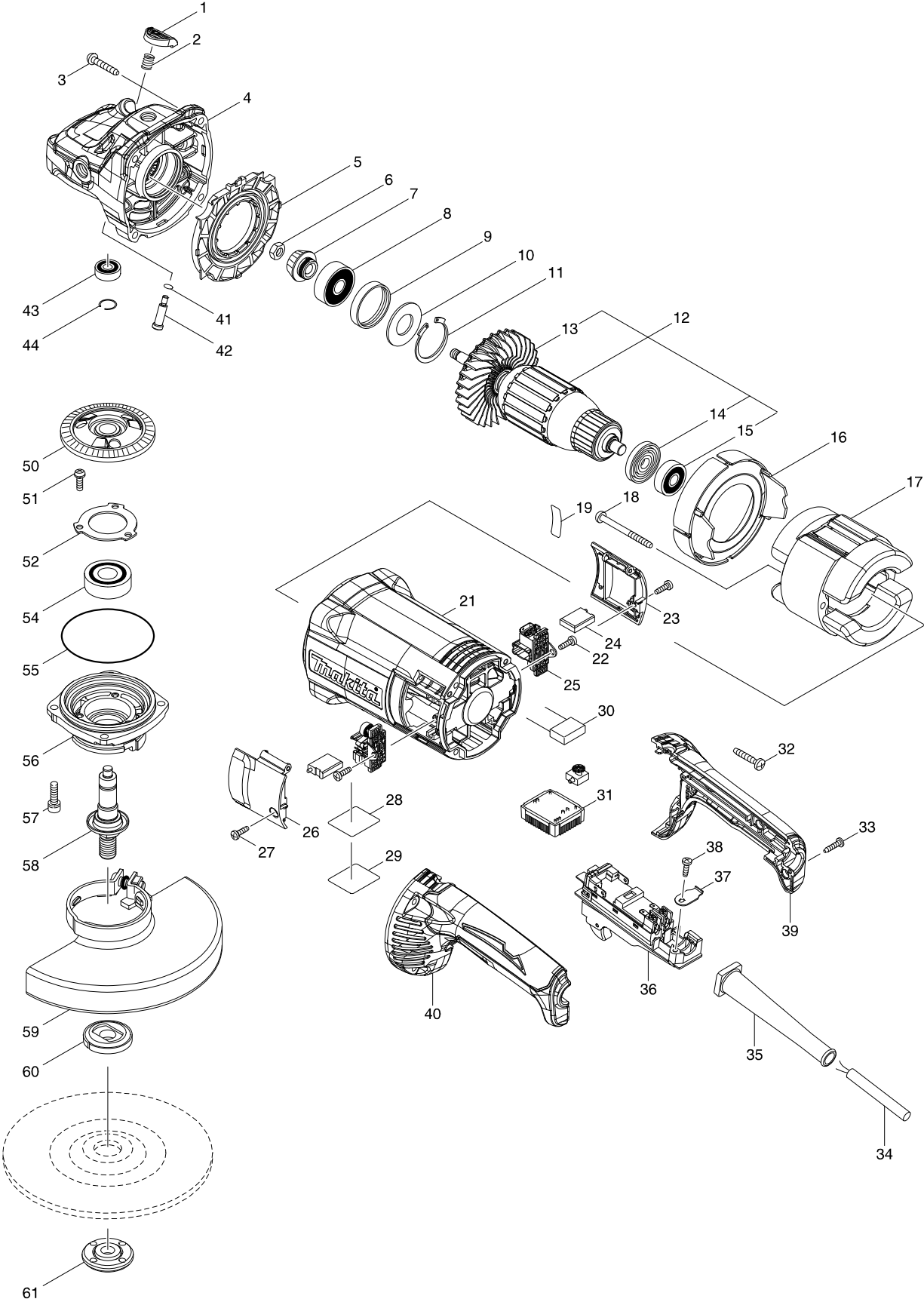

Model No. GA7060R 180MM ANGLE GRINDER

Item	Parts No.	Description	I/C	QTY	N/O	Opt. 1	Opt. 2	NOTE
001	456247-8	PIN CAP		1		40169390		
002	234391-9	COMPRESSION SPRING 8		1		73209090		
003	251489-7	TAPPING SCREW 5X30		4		73181500		
004	143485-8	GEAR HOUSING COMPLETE		1		84679900		
C10	263002-9	RUBBER PIN 4		1		40169390		
005	456238-9	DIFFUSER		1		84679900		
006	252194-9	HEX. NUT M8		1		73181500		
007	227655-8	SPIRAL BEVEL GEAR 17		1		84679900		
008	211132-0	BALL BEARING 6301DDW		1		84821090		
009	262085-6	RUBBER RING 38		1		73182990		
010	267299-2	FLAT WASHER 20		1		73182200		
011	962211-4	RETAINING RING R-42		1		73182990		
012	513449-0	ARMATURE ASS'Y 240V		1		85030090		
D10		INC. 13-15						
013	240161-6	FAN 86		1		84145190		
014	681630-2	INSULATION WASHER		1		73182200		
015	211087-9	BALL BEARING 6200DDW		1		84821090		
016	456239-7	BAFFLE PLATE		1		73182990		
017	621779-6	FIELD 240V		1		85030090		
018	266044-2	TAPPING SCREW 5X60		2		73181500		
019	851V07-9	GA7060R SERIAL NO. LABEL		1				
021	456240-2	MOTOR HOUSING		1		84679900		
022	266385-6	TAPPING SCREW 4X14		2		73181500		
023	143950-7	BRUSH HOLDER COVER R COMPLET		1	*	84679900		
023-1	456246-0	BRUSH HOLDER COVER R	>	1		73269099		
024	197129-2	CARBON BRUSH CB-218		1		85452000		
025	643714-4	BRUSH HOLDER		2	*	82078000		
025-1	643715-2	BRUSH HOLDER	<	2		82078000		
026	143949-2	BRUSH HOLDER COVER L COMPLET		1	*	84679900		
026-1	456245-2	BRUSH HOLDER COVER L	>	1		73269099		
027	266385-6	TAPPING SCREW 4X14		2		73181500		
028	851V04-5	GA7060R NAME PLATE		1				
029	808D02-2	CLEAR LABEL		1				
031	620470-3	CONTROLLER		1		84679900		
032	251489-7	TAPPING SCREW 5X30		4		73181500		
033	266326-2	TAPPING SCREW 4X18		2		73181500		
034	695107-1	POWER SUPPLY CORD 1.5-2-2.5		1		85442090		
035	682573-1	CORD GUARD 10		1		73182990		
036	632F77-9	SWITCH UNIT		1		85366990		
037	687169-3	STRAIN RELIEF		1		73182990		
038	266385-6	TAPPING SCREW 4X14		1		73181500		
039	183C62-2	HANDLE SET		1		84679900		
D10		INC. 40						
040	183C62-2	HANDLE SET		1		84679900		
D10		INC. 39						
041	213026-5	O RING 7		1		40169320		
042	256571-7	SHOULDER PIN 7		1		73182990		
043	211032-4	BALL BEARING 608ZZ		1		84821090		

