

Model No. DUH602 600MM CORDLESS HEDGE TRIMMER

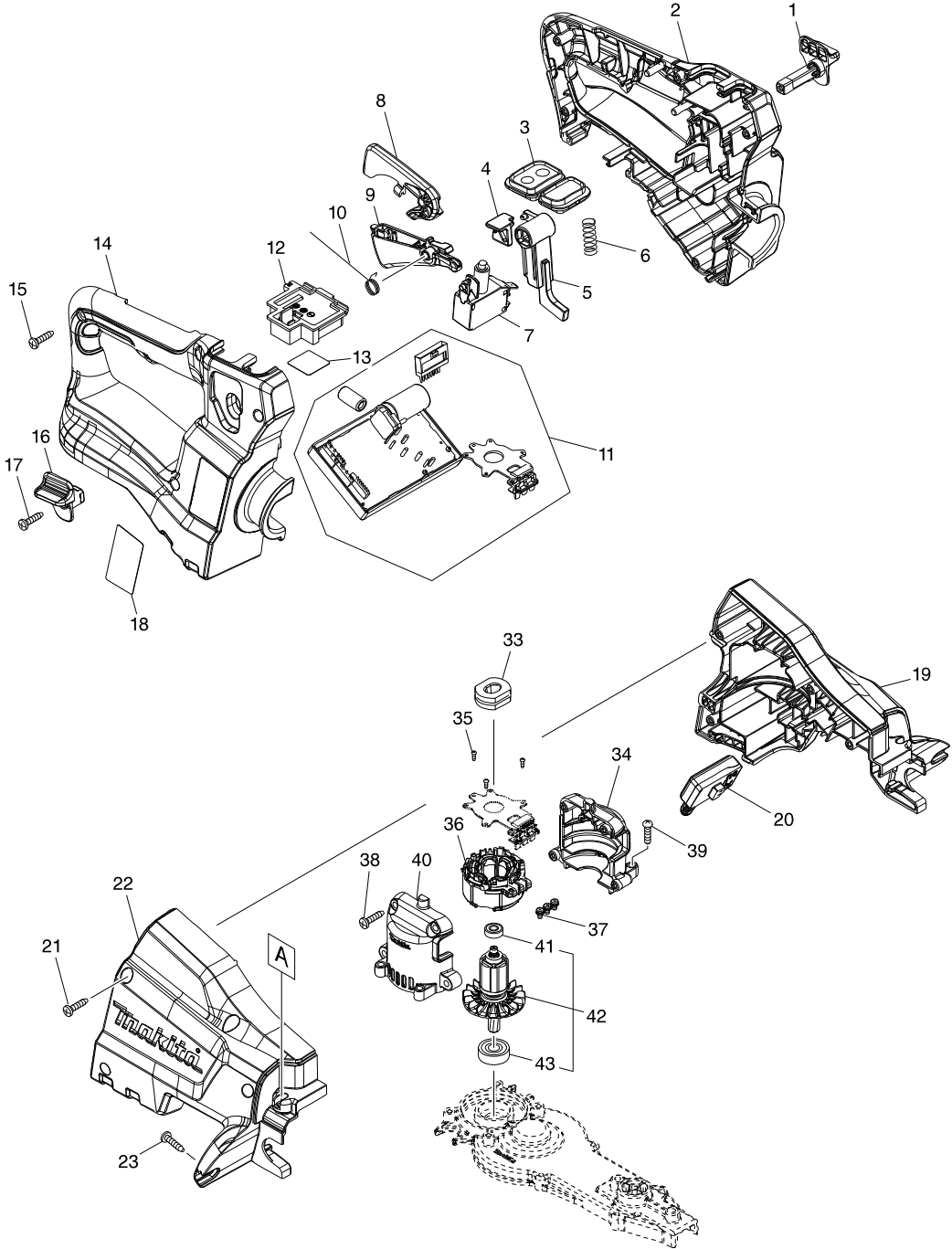

Model No. DUH602 600MM CORDLESS HEDGE TRIMMER

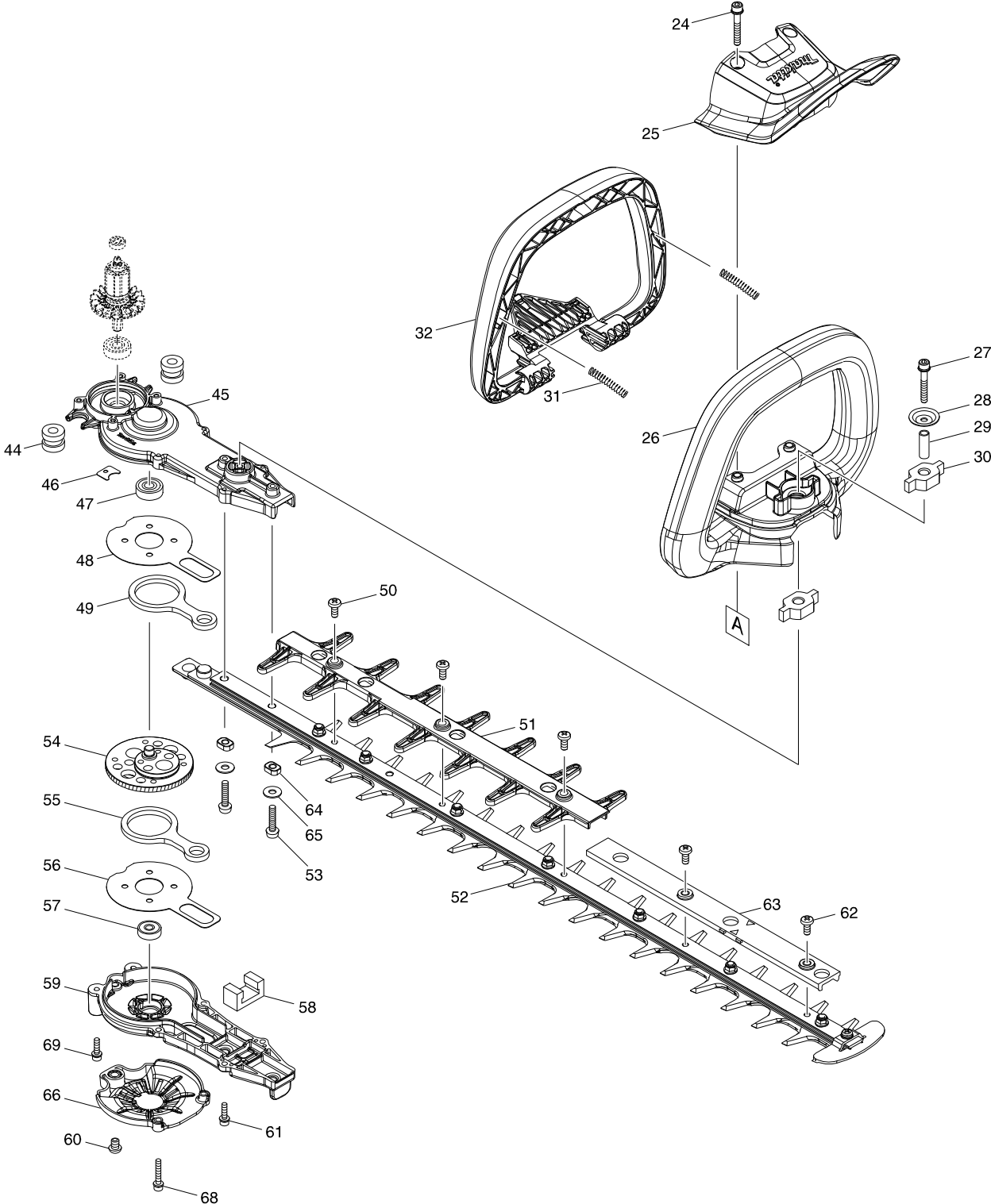

Model No. DUH602 600MM CORDLESS HEDGE TRIMMER

Item	Parts No.	Description	I/C	QTY	N/O	Opt. 1	Opt. 2	NOTE
001	458406-0	LOCK LEVER L		1		73182990		
002	183J51-9	HANDLE SET		1		84679900		
	C10	263005-3		2		40169390		
	D10							
003	140A04-7	SUB CONTROLLER COMPLETE		1		84679900		
	C10	806G56-1		1				
	C20	817C42-3		1				
004	458570-7	SLIDER		1		73182990		
005	458405-2	LOCK ARM		1		73182990		
006	234204-4	COMPRESSION SPRING 8		1		73209090		
007	650781-2	SWITCH C3JW-6B-P		1		85366990		
008	458403-6	LOCK OFF LEVER		1		73182990		
009	458404-4	SWITCH LEVER R		1		73182990		
010	232454-5	TORSION SPRING 10		1		73209090		
011	620818-9	CONTROLLER		1		84679900		
012	644809-6	TERMINAL		1				
013	855G51-8	DUH602 SERIAL NO. LABEL		1				
014	183J51-9	HANDLE SET		1		84679900		
	C10	263005-3		2		40169390		
	D10							
015	266326-2	TAPPING SCREW 4X18		6		73181500		
016	458407-8	LOCK LEVER R		1		73182990		
017	266326-2	TAPPING SCREW 4X18		1		73181500		
018	855G45-3	DUH602 NAME PLATE		1				
019	183K21-4	HOUSING SET		1		84679900		
	C10	252143-6		2				
	C20	424344-8		4		84679900		
	D10							
020	651083-9	SWITCH C3XA-1PSPM		1		85365000		
021	266326-2	TAPPING SCREW 4X18		4		73181500		
022	183K21-4	HOUSING SET		1		84679900		
	C10	252143-6		2				
	C20	424344-8		4		84679900		
	D10							
023	266326-2	TAPPING SCREW 4X18		2		73181500		
024	265182-7	+ PAN HEAD SCREW M5X25		2		73181500		
025	458399-1	PROTECTOR		1		84679900		
026	458400-2	FRONT GRIP E		1		84679900		
027	251476-6	H.S.H.BOLT M5X35 WITH WR		1		73181500		
028	253416-0	DISH WASHER 5		1		73182200		
029	257678-2	SLEEVE 6		1		73182990		
030	422260-8	RUBBER SLEEVE 8		2		40169390		
031	233222-9	COMPRESSION SPRING 5		2		73209090		
032	458402-8	SWITCH LEVER F		1		73182990		
033	422261-6	RUBBER SLEEVE		1		40169390		
034	183J52-7	MOTOR HOUSING SET		1	*	84679900		
	D10				*			
034-1	183L66-8	MOTOR HOUSING SET	<	1				

Model No. DUH602 600MM CORDLESS HEDGE TRIMMER

Item	Parts No.	Description	I/C	QTY	N/O	Opt. 1	Opt. 2	NOTE
D10		INC. 40						
035	266490-9	TAPPING SCREW PT 2X6		3		73181500		
036	629352-6	STATOR		1		85030090		
037	652069-6	FLAT HEAD SCREW M3X6		3		73181500		
038	266326-2	TAPPING SCREW 4X18		4		73181500		
039	265178-8	PAN HEAD SCREW M4X16		4				
040	183J52-7	MOTOR HOUSING SET		1	*	84679900		
D10		INC. 34			*			
040-1	183L66-8	MOTOR HOUSING SET	<	1				
D10		INC. 34						
041	211157-4	BALL BEARING 695ZZ		1		84821090		
042	519557-5	ROTOR ASSY		1		84679900		
D10		INC. 41,43						
043	211032-4	BALL BEARING 608ZZ		1		84821090		
044	422259-3	RUBBER SLEEVE 8		2		40169390		
045	140F22-5	GEAR HOUSING COMPLETE		1		84834000		
C10	424344-8	DAMPER		1		84679900		
046	458417-5	GASKET		1		40169390		
047	211032-4	BALL BEARING 608ZZ		1		84821090		
048	347361-0	FRICITION PLATE		1		73182990		
049	347362-8	CONNECTING ROD		1		73182990		
050	915211-3	BINDING HEAD SCREW M5X12		3				
051	458408-6	GUARD E		1		84679900		
052	199599-1	SHEAR BLADE ASSEMBLY 600S SET		1	*			
C10	345205-8	BRANCH CATCHER		1	*	73182200		
C20	911208-0	PAN HEAD SCREW M5X10		1	*	73181500		
C30	188369-3	OIL VESSEL SET		1	*			
D10		INC. 64,65			*			
052-1	199599-1	SHEAR BLADE ASSEMBLY 600S SET	<	1				
C10	345205-8	BRANCH CATCHER		1		73182200		
C20	911208-0	PAN HEAD SCREW M5X10		1		73181500		
C30	188369-3	OIL VESSEL SET		1				
D10		INC. 64,65						
053	265182-7	+ PAN HEAD SCREW M5X25		2		73181500		
054	140B79-2	GEAR COMPLETE		1		84834000		
055	347362-8	CONNECTING ROD		1		73182990		
056	347361-0	FRICITION PLATE		1		73182990		
057	211499-6	BALL BEARING 626ZZ		1		84821090		
058	443159-4	SEAL		1		40169390		
059	140B62-9	GEAR HOUSING COVER COMPLETE		1		84834000		
060	265338-2	H.S.BOTTON HEAD BOLT M6X8		1		84679900		
061	265A29-1	HEX. SOCKET HEAD BOLT M4X16WRI		2		84679900		
062	915211-3	BINDING HEAD SCREW M5X12		2				
063	458628-2	SPACER 600		1		84679900		
064	257465-9	RING 5		2		84679900		
065	253804-1	FLAT WASHER 6		2		84679900		
066	458907-8	UNDER COVER		1		84679900		
068	265698-2	HEX. SOCKET HEAD BOLT M4X25WRI		2		84679900		

