

Model No. UH5261 520MM HEDGE TRIMMER

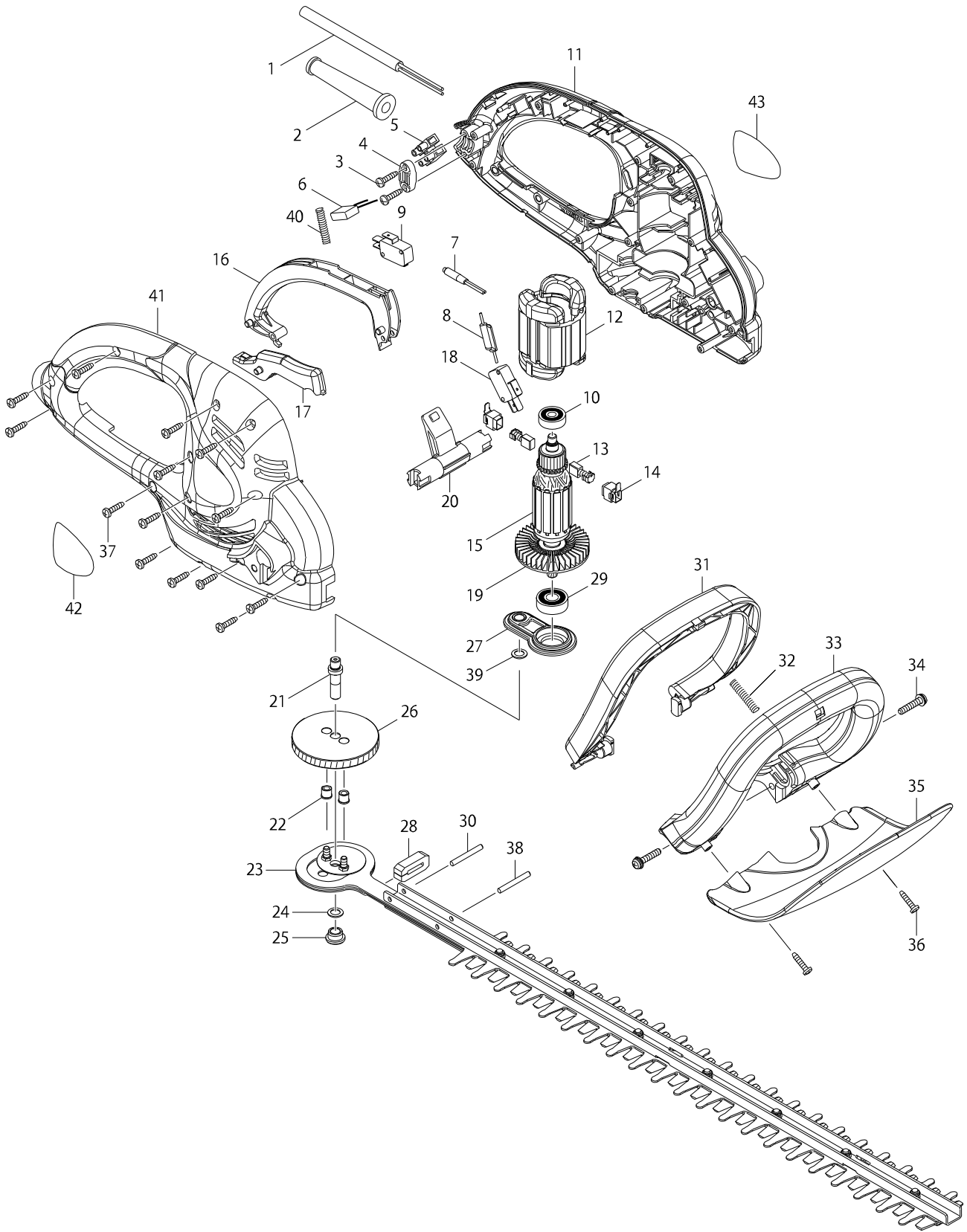

Model No. UH5261 520MM HEDGE TRIMMER

Item	Parts No.	Description	I/C	QTY	N/O	Opt. 1	Opt. 2	NOTE
001	666080-2	POWER SUPPLY CORD 1.0-2-0.3		1				
002	682569-2	CORD GUARD 8-85		1				
003	266326-2	TAPPING SCREW 4X18		2				
004	687123-7	STRAIN RELIEF		1				
005	654531-7	TERMINAL BLOCK 2P		1				
009	650642-6	SWITCH		1				
010	210030-5	BALL BEARING 627ZZ		1				
011	187052-9	HOUSING SET		1				
C10	931202-6	HEX. NUT M5		2				
D10		INC. 41,43						
012	621753-4	FIELD 220-240V		1				
013	191962-4	CARBON BRUSH CB-419		1				
014	643923-5	BRUSH HOLDER		2				
015	515824-6	ARMATURE ASS'Y 240V		1				
D10		INC. 10,19,29						
016	452677-1	SWITCH LEVER A		1				
017	452680-2	SWITCH LEVER C		1				
018	650642-6	SWITCH		1				
019	241850-6	FAN 60		1				
020	452681-0	SWITCH ARM		1				
021	326034-8	SPINDLE		1				
022	262570-9	NYLON SLEEVE 5		2				
023	140827-7	SHEAR BLADE COMPLETE		1				
024	253777-8	FLAT WASHER 8		1				
025	214064-0	PLANE BEARING 8		1				
026	227745-7	HELICAL GEAR 67		1				
027	140828-5	BEARING BOX COMPLETE		1				
028	423417-4	DUST GUARD		1				
029	211062-5	BALL BEARING 6000ZZ		1				
030	268136-3	PIN 4		1				
031	452678-9	SWITCH LEVER B		1				
032	233156-6	COMPRESSION SPRING 5		1				
033	452682-8	FRONT GRIP		1				
034	911243-8	PAN HEAD SCREW M5X25		2				
035	140829-3	PROTECTOR COMPLETE		1				
036	266326-2	TAPPING SCREW 4X18		2				
037	266326-2	TAPPING SCREW 4X18		14				
038	268136-3	PIN 4		1				
039	253777-8	FLAT WASHER 8		1				
040	233156-6	COMPRESSION SPRING 5		1				
041	187052-9	HOUSING SET		1				
C10	931202-6	HEX. NUT M5		2				
D10		INC. 11,43						
042	869270-8	UH5261 NAME PLATE		1				
043	892589-0	MAKITA LOGO LABEL		1				
A01	194677-2	CORD HOLDER COMPLETE SET		1				
A02	158024-1	HOOK COMPLETE		1				
A03	452685-2	BLADE COVER		1				