

Model No. M9509 100MM ANGLE GRINDER

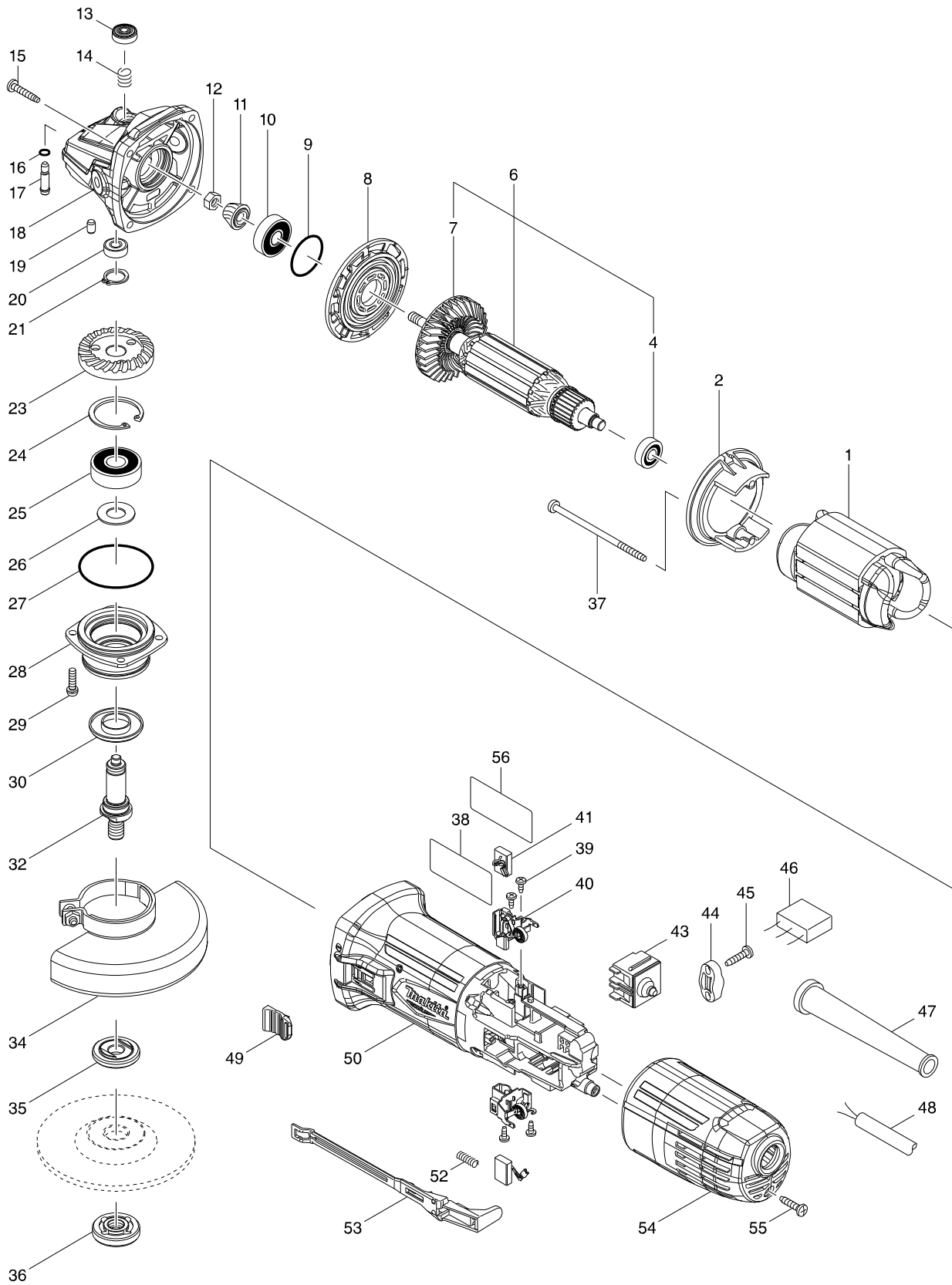

Model No. M9509 100MM ANGLE GRINDER

Item	Parts No.	Description	I/C	QTY	N/O	Opt. 1	Opt. 2	NOTE
001A	628378-5	FIELD 220-240V		1				
001L	628198-7	FIELD 115V		1				
002	457137-8	BAFFLE PLATE		1				
004	210169-4	BALL BEARING 607LLB		1				
D10		INC. 4,7						
006A	513948-2	ARMATURE ASS'Y 220-240V		1				
006L	513946-6	ARMATURE ASS'Y 115V		1				
007	240076-7	FAN 56		1				
008	457122-1	BEARING RETAINER		1				
009	213407-3	O RING 26		1				
010	210084-2	BALL BEARING 629ZZ		1				
011	221475-2	SPIRAL BEVEL GEAR 10		1				
012	252186-8	HEX. NUT M6		1				
013	419589-1	CAP		1				
014	233376-2	COMPRESSION SPRING 8		1				
015	266324-6	TAPPING SCREW 4X22		4				
016	213960-9	O RING 5		1				
017	268228-8	SHOULDER PIN 5		1				
018	319487-8	GEAR HOUSING		1				
019	263002-9	RUBBER PIN 4		1				
020	210033-9	BALL BEARING 696ZZ		1				
021	961052-5	RETAINING RING S-12		1				
023	221476-0	SPIRAL BEVEL GEAR 37		1				
024	257978-0	RETAINING RING(INT)R-32		1				
025	211345-3	BALL BEARING 6201DDW		1				
026	267238-2	FLAT WASHER 12		1				
027	213622-9	O RING 45		1				
028	123847-6	BEARING BOX ASSEMBLY		1				
D10		INC. 27						
029	265100-5	PAN HEAD SCREW M4X16		4				
030	345464-4	LABYRINTH RING		1				
032	326828-1	SPINDLE		1				
034	126477-2	WHEEL COVER 100M ASSEMBLY		1				
035	224470-1	INNER FRANGE 30		1				
036	224585-4	LOCK NUT 10-30		1				
037	266345-8	TAPPING SCREW 4X80		2				
038	852S62-6	M9509 NAME PLATE		1				
039	266492-5	TAPPING SCREW 3X8		4				
040	643717-8	BRUSH HOLDER		2				
041	194074-2	CARBON BRUSH CB-325		1				
043	651947-7	SWITCH 1247.0302		1				
044	687123-7	STRAIN RELIEF		1				
045	266326-2	TAPPING SCREW 4X18		2				
047	682583-8	CORD GUARD		1				
048A	666930-1	POWER SUPPLY CORD 0.75-2-2.0		1				
048L	666053-5	POWER SUPPLY CORD 1.0-2-2.0		1				
049	418016-5	SWITCH KNOB		1				
050	457131-0	MOTOR HOUSING		1				

